

MODEL 5250 CUBICLE and WINDOW TRACK

H & H Specialties' Cubicle Track is designed and engineered to provide patient privacy in hospitals, nursing homes, and other medical facilities. Window track is designed for straight operation of residential, commercial, and industrial light duty curtains.

The track is extruded aluminum with a clear anodized finish and will accommodate a variety of job conditions. Carriers are engineered for smooth and quiet operation for years of trouble-free service.

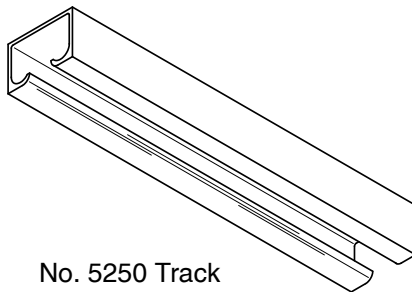

No. 5250 Track

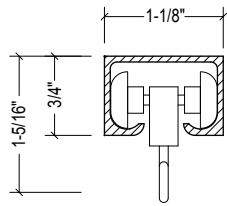

DIMENSION DRAWINGS

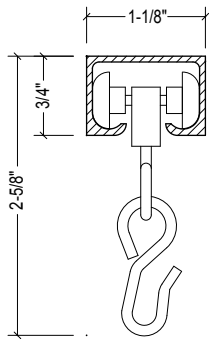

No. 5250 CUBICLE and WINDOW TRACK

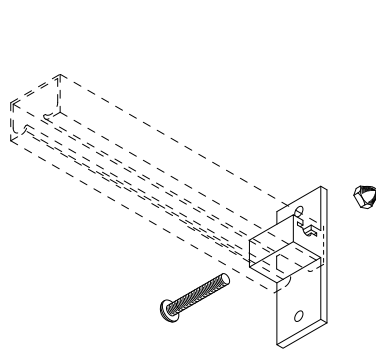

No. 5202
Wall Bracket

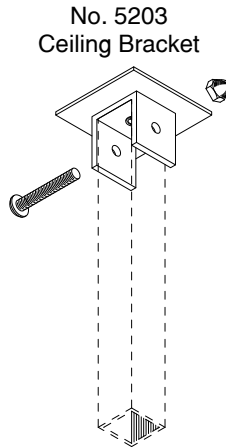

No. 5203
Ceiling Bracket

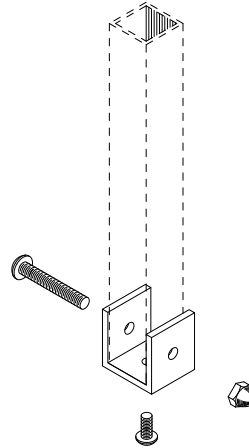

No. 5204
Track Bracket

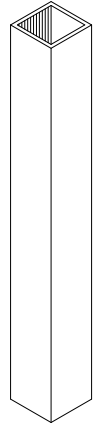

No. 5205
Suspension
Tubing
8' Stock Length

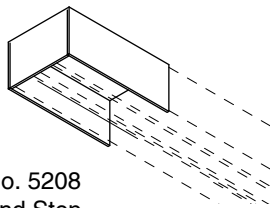

No. 5208
End Stop

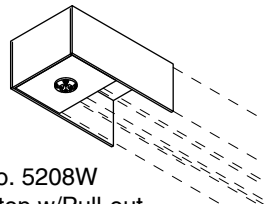

No. 5208W
End Stop w/Pull-out

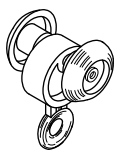

No. 5215
Nylon Carrier



No. 5215-H
Nylon Carrier
w/Hook



No. 5230B
Hook

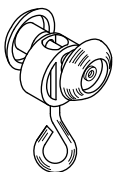

No. 5216
Nylon Carrier
w/Swivel Eye



No. 5216-H
Nylon Carrier
w/Swivel Eye
and Hook



No. 5222
18" Bead
Drop Chain



No. 5223
6" Spacer Chain

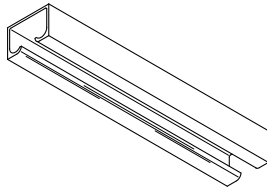

No. 5250 Track
6', 12', 16' and 20' Stock Lengths

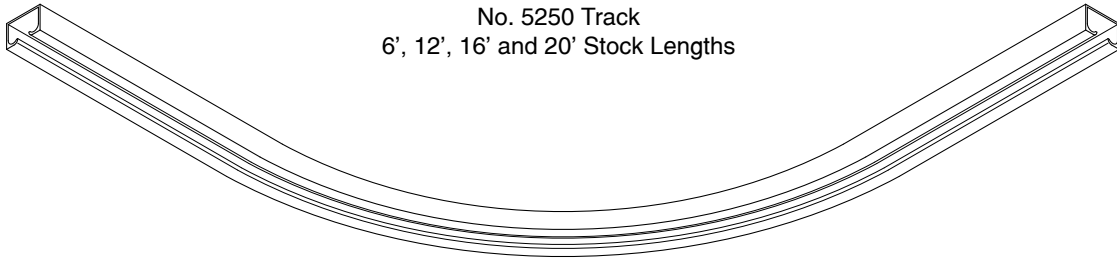

No. 5252
90 Degree Curve w/ Splices
2' x 2'

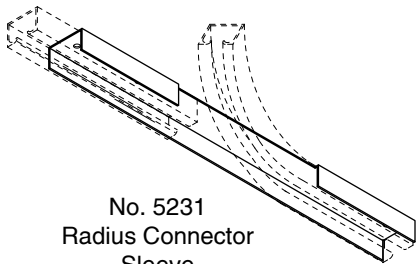

No. 5231
Radius Connector
Sleeve

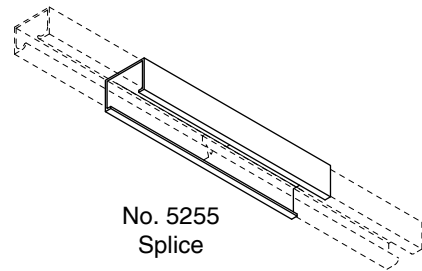

No. 5255
Splice

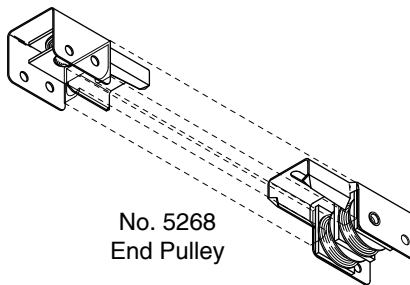

No. 5268
End Pulley

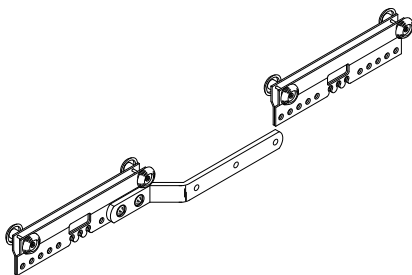

No. 5282
Master Carrier w/Arm
Cannot be used on curved tracks.

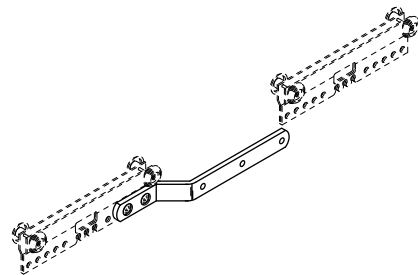

No. 5288
Offset Arm



TYPICAL INSTALLATIONS

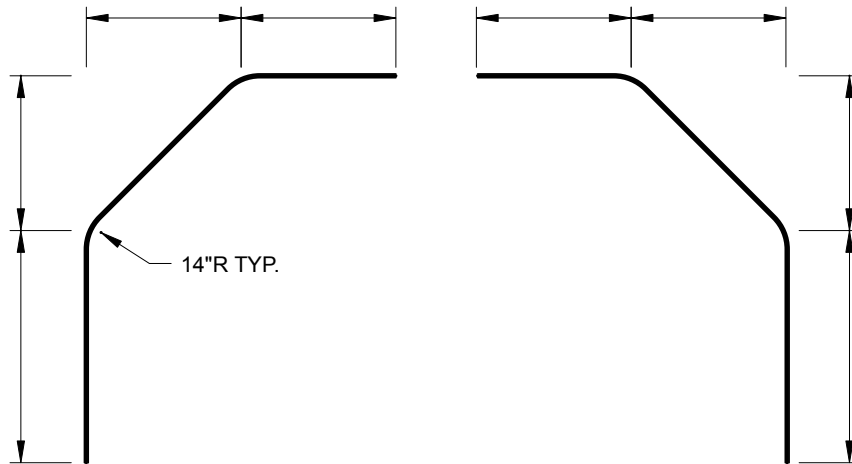
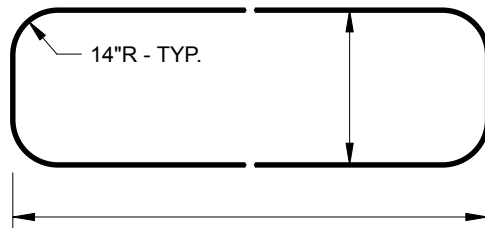
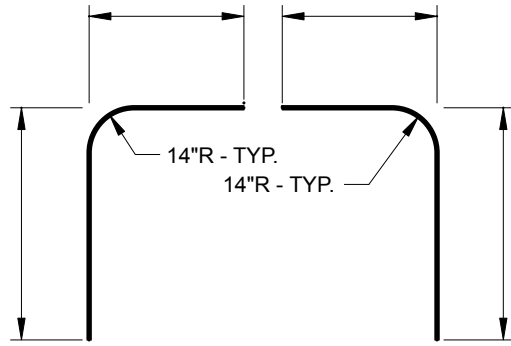

5250 track is available in 6', 12', 16', and 20' stock lengths.

